

ASSEMBLY INSTRUCTION

Adelina 4'6 Bed



BEFORE YOU START

1. Choose a clean, level, spacious assembly area. Avoid hard surfaces that may damage the product.
2. Check and ensure that you have all required contents for complete assembly.
3. Always read the assembly instructions carefully before beginning assembly.
4. The packaging and contents can be a choking hazard, therefore keep out of reach of small children at all times.
5. Do not over tighten the bolts as this may damage the thread.

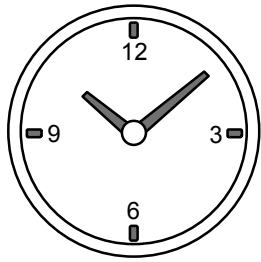

Approximate Assembly
Time: 20mins

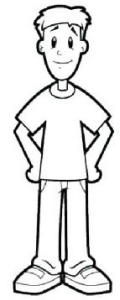

2 person needed

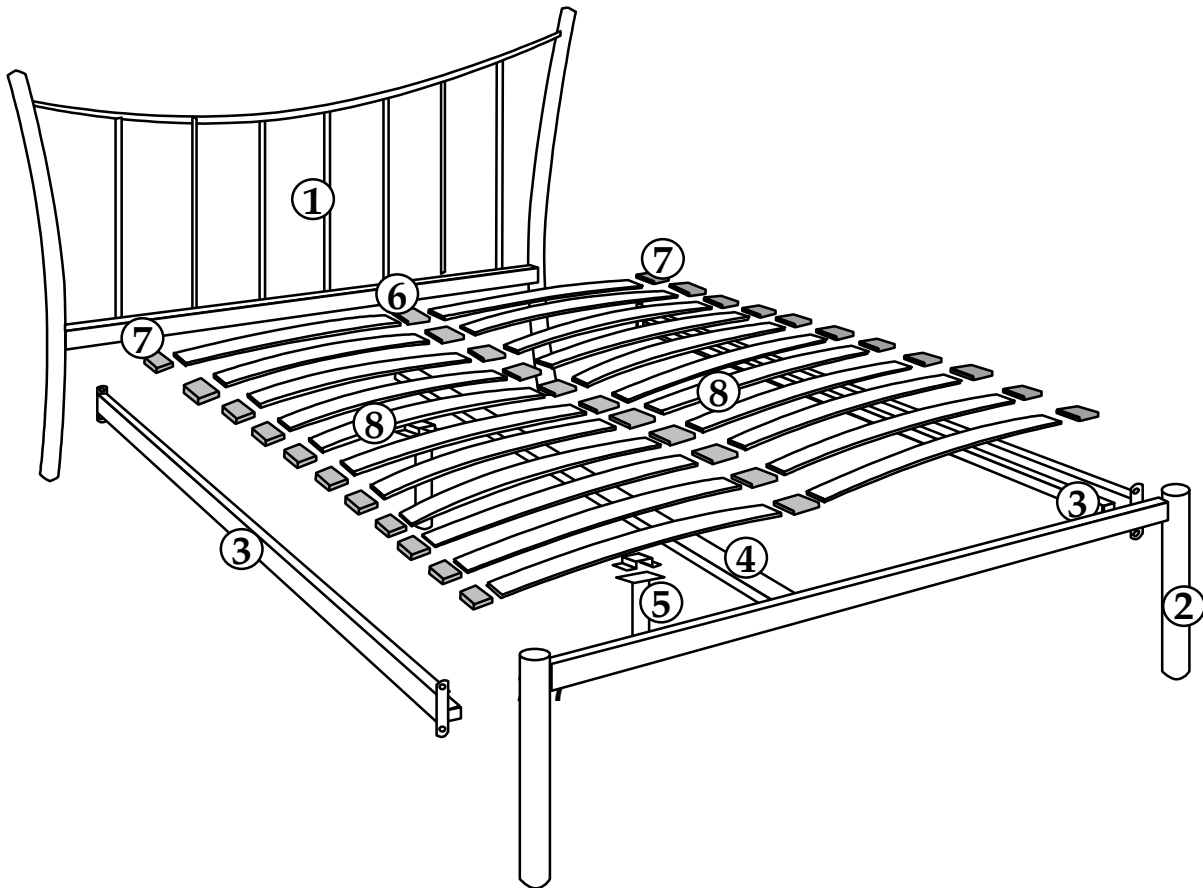

EXPLODED EXAMPLES

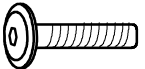
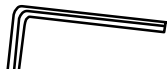
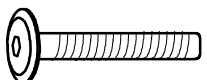
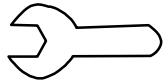

FITTINGS

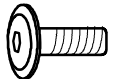
A		M6x20mm bolt x 8pcs	E		M4 Allen Key x 1pc
B		M6x35mm bolt x 4pcs	F		Spanner x 1pc
C		M6 Hex Nut x 8pcs			
D		M6x15mm bolt x 4pcs			

Step 1

Attach the Siderails to both the headend and footend.

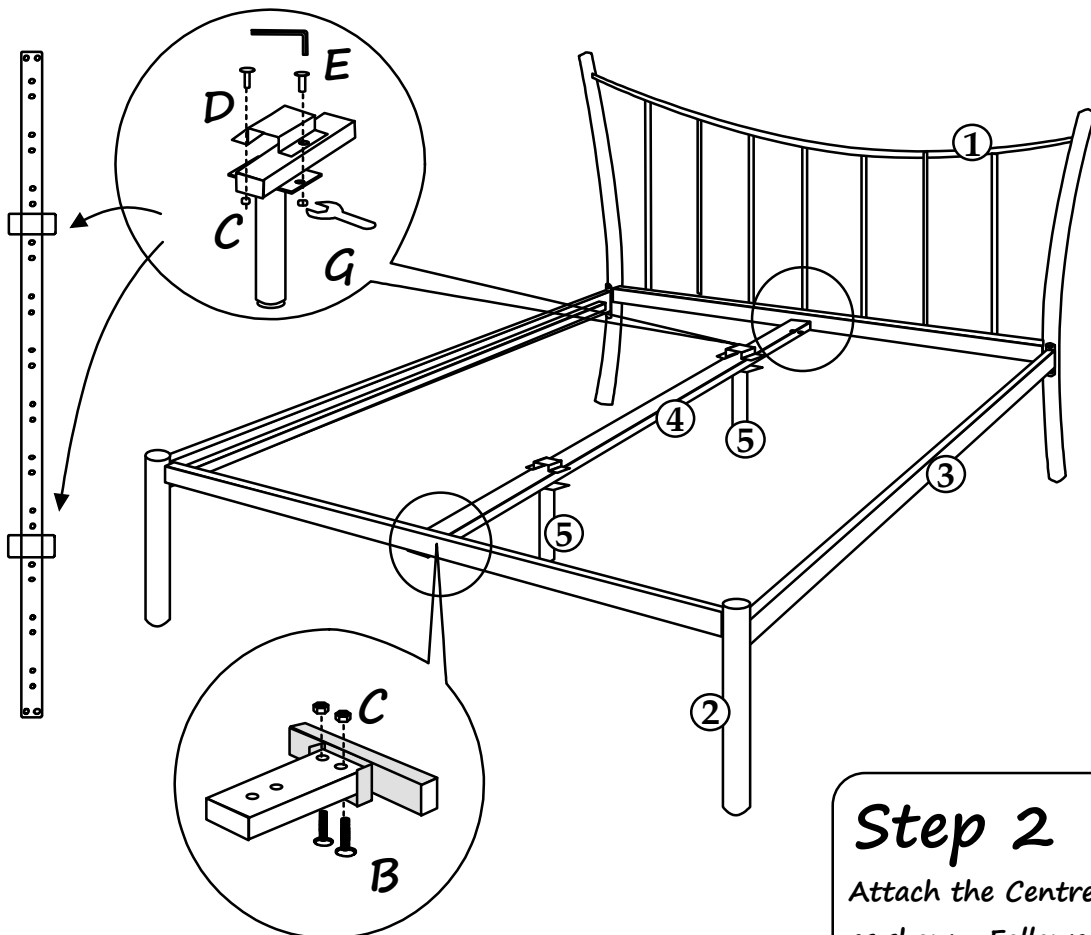
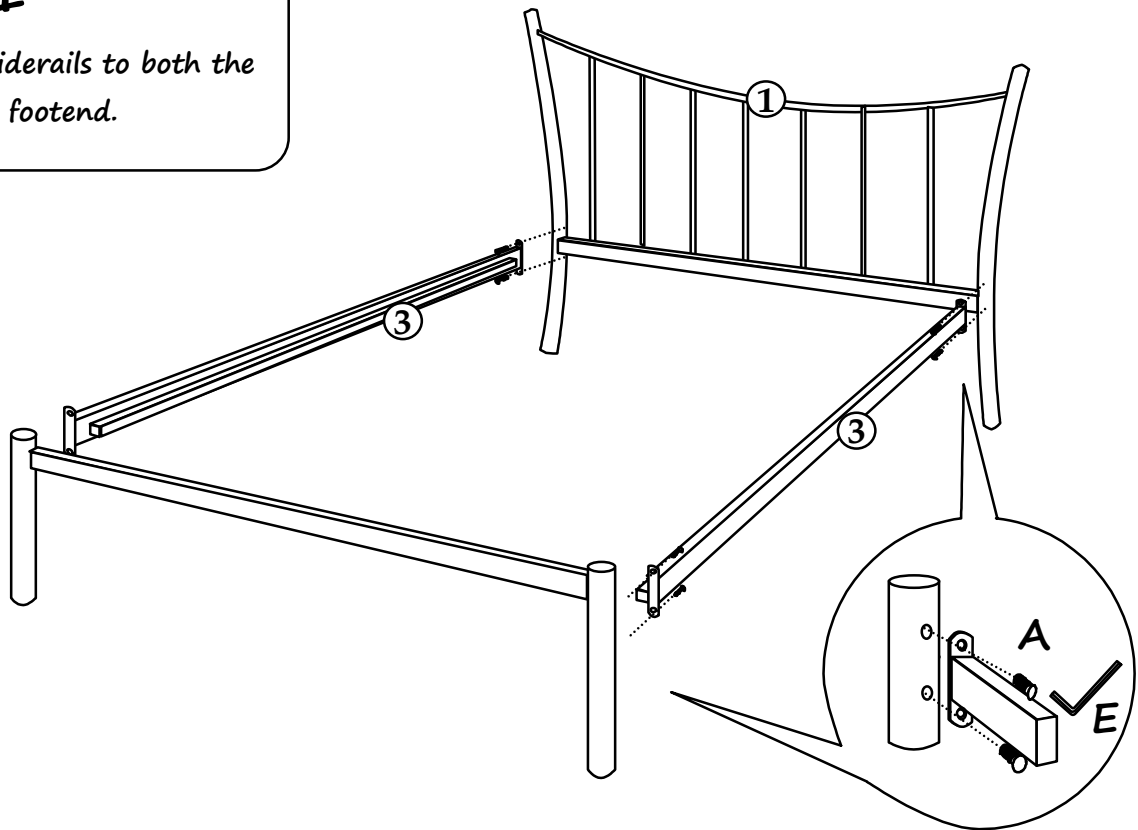

Step 2

Attach the Centre rail to the bedend as shown. Followed by the support legs on centre rail.

Step 3

Align the pins on the Plastic Holders to the holes along the Centre Rail and the Siderails. Gently tap them into the holes.

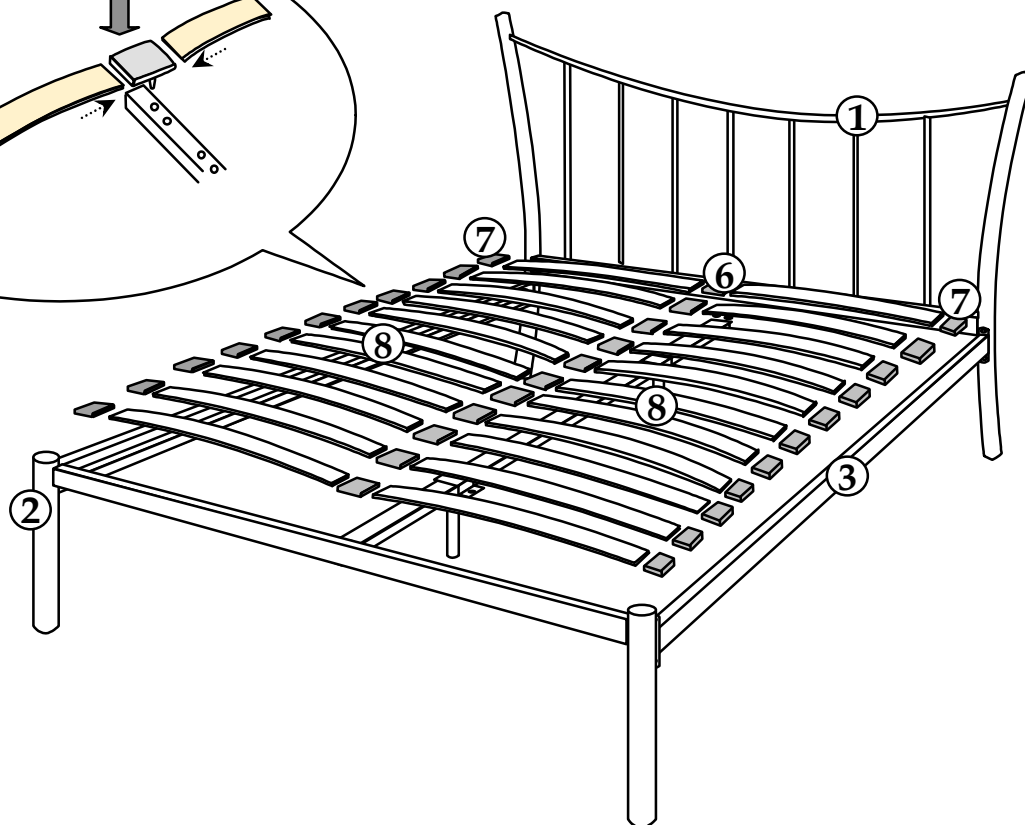
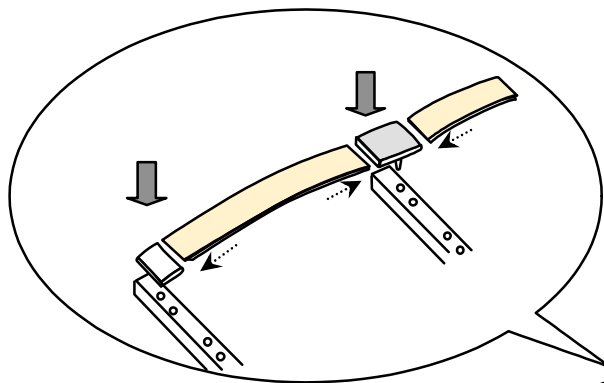

- Retightening of all fixing periodically is recommended.
- When moving your fully assembled bed you must first remove the mattress and lift the frame into position, take care when lifting and always have two people handling the bed. PLEASE DO NOT DRAG THE BED as this will cause damage to the rail.
- It is advisable to use approved cleaning products when cleaning the furniture and bed frame as certain chemical based cleaners could have an adverse effect on the bed finish.
- If any queries, please contact your seller.